

Charmline®



225MM LONG REACH DRYWALL SANDER (230V)

MODEL NO: DWS225LR 230V

PART NO: 3400404

OPERATION & MAINTENANCE INSTRUCTIONS

UK
CA | CE



DL0222 REV 2

INTRODUCTION

Thank you for purchasing this CLARKE 225mm 230v Long Reach Drywall Sander.

Read all safety warnings, instructions, illustrations and specifications provided with this power tool. In doing so you will ensure the safety of yourself and that of others around you, and you can look forward to your purchase giving you long and satisfactory service. Failure to follow all instructions listed may result in electric shock, fire and/or serious injury.

GUARANTEE

This product is guaranteed against faulty manufacture for a period of 12 months from the date of purchase. Please keep your receipt which will be required as proof of purchase.

This guarantee is invalid if the product is found to have been abused or tampered with in any way, or not used for the purpose for which it was intended.

Faulty goods should be returned to their place of purchase, no product can be returned to us without prior permission.

This guarantee does not effect your statutory rights.

ENVIRONMENTAL RECYCLING POLICY







Through purchase of this product, the customer is taking on the obligation to deal with the WEEE in accordance with the WEEE regulations in relation to the treatment, recycling & recovery and environmentally sound disposal of the WEEE.

In effect, this means that this product must not be disposed of with general household waste. It must be disposed of according to the laws governing Waste Electrical and Electronic Equipment (WEEE) at a recognised disposal facility.

SPECIFICATION

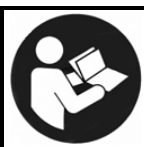
Electrical Supply	230V 50Hz 1 ph
Power rating	750 Watt
Fuse rating	13 Amp
No Load Speed (variable)	800 - 1750 rpm
Net Weight	4.1 kg
Disc Sanding Size	225 mm
Sanding Discs	Aluminium Oxide (P80, P100, P120, P150, P180, P240)
IP Rating	IP20
Dust Extract Diameter	32mm(Internal), 38mm(External)
Sound Power	102 dB Lwa (Uncertainty Factor, K: 3 dB)
Vibration Emissions	3.95 m/s ² / uncertainty value (k) =1.5 m/s ²
Dimensions: Folded (LxWxD)	690mm x 269mm x 180mm
Dimensions: Min. (LxWxD)	1440mm x 269mm x 180mm
Dimensions: Max. (LxWxD)	1700mm x 269mm x 180mm

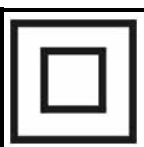
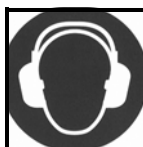
SAFETY SYMBOLS

	Read instruction manual before use		Wear dust mask
	Class 2 Double Insulated		Wear ear defenders
	WEEE Directive		Wear safety glasses

SAFETY PRECAUTIONS



WARNING: READ ALL INSTRUCTIONS. FAILURE TO FOLLOW ALL INSTRUCTIONS LISTED BELOW MAY RESULT IN ELECTRIC SHOCK, FIRE AND/OR SERIOUS INJURY. THE TERM "POWER TOOL" IN ALL WARNINGS LISTED BELOW REFERS TO YOUR LONG REACH DRYWALL SANDER.

1) WORK AREA SAFETY

- a. Keep work area clean and well lit. Dark areas invite accidents.
- b. DO NOT operate power tools in explosive atmospheres, such as in the presence of flammable liquids or gases.
- c. Keep children and bystanders away while operating a power tool. Distractions can cause you to lose control.

2) ELECTRICAL SAFETY

- a. Power tool plugs must match the power outlet. NEVER modify the plug in any way. DO NOT use any adapter plugs with earthed (grounded) power tools. Unmodified plugs and matching power outlets will reduce risk of electric shock.
- b. Avoid body contact with earthed or grounded surfaces, such as pipes, radiators, ranges and refrigerators. There is an increased risk of electric shock if your body is earthed or grounded.
- c. DO NOT expose power tools to rain or wet conditions. Water entering a power tool will increase the risk of electric shock.
- d. DO NOT abuse the cable. Never use the cable for carrying, pulling or unplugging the power tool. Keep cable away from heat, oil, sharp edges or moving parts. Damaged or entangled cables increase the risk of electric shock.
- e. When operating a power tool outdoors, use an extension lead suitable for outdoor use. Use of a cable suitable for outdoor use reduces the risk of electric shock.
- f. If operating a power tool in a damp location is unavoidable, use a residual current device (RCD) protected supply. Use of an RCD reduces the risk of electric shock.

3) PERSONAL SAFETY

- a. Stay alert, watch what you are doing and use common sense when operating a power tool. DO NOT use a power tool while you are tired or under the influence of drugs, alcohol or medication. A moment of inattention while operating power tools may result in serious personal injury.

- b. Use personal protective equipment. ALWAYS wear eye protection. Protective equipment such as dust mask, non-skid safety shoes, hard hat, or hearing protection used for appropriate conditions will reduce personal injuries.
- c. Prevent unintentional starting. Ensure the trigger is in the off-position before connecting to power source, picking up or carrying the tool. Carrying power tools with your finger on the trigger or energising power tools that have the switch on invites accidents.
- d. Remove any adjusting key or wrench before turning the power tool on. A wrench or a key left attached to a rotating part of the power tool may result in personal injury.
- e. DO NOT overreach. Keep proper footing and balance at all times. This enables better control of the power tool in unexpected situations.
- f. Dress properly. DO NOT wear loose clothing or jewellery. Keep your hair, clothing and gloves away from moving parts. Loose clothes, jewellery or long hair can be caught in moving parts.
- g. If devices are provided for the connection of dust extraction and collection facilities, ensure these are connected and properly used. Use of dust collection can reduce dust-related hazards.

4) POWER TOOL USE AND CARE

- a. DO NOT force the power tool. Use the correct power tool for your application. The correct power tool will do the job better and safer at the rate for which it was designed.
- b. DO NOT use the power tool if the switch does not turn it on and off. Any power tool that cannot be controlled with the switch is dangerous and must be repaired.
- c. Disconnect the plug from the power source before making any adjustments, changing accessories, or storing power tools. Such preventive safety measures reduce the risk of starting the power tool accidentally.
- d. Store idle power tools out of the reach of children and do not allow persons unfamiliar with the power tool or these instructions to operate the power tool. Power tools are dangerous in the hands of untrained users.
- e. Maintain power tools. Check for misalignment or binding of moving parts, breakage of parts and any other condition that may affect the power tool's operation. If damaged, have the power tool repaired before use. Many accidents are caused by poorly maintained power tools.
- f. Use the power tool, and accessories in accordance with these instructions, taking into account the working conditions and the work to

be performed. Use of the power tool for operations different from those intended could result in a hazardous situation.

5) SERVICE

- a. Have your power tool serviced by a qualified repair person using only identical replacement parts. This will ensure that the safety of the power tool is maintained.

SAFETY INSTRUCTIONS FOR KICKBACK



WARNING: KICKBACK IS A SUDDEN REACTION TO A PINCHED OR SNAGGED ROTATING WHEEL, BACKING PAD, BRUSH OR ANY OTHER ACCESSORY. PINCHING OR SNAGGING CAUSES RAPID STALLING OF THE ROTATING ACCESSORY WHICH IN TURN CAUSES THE UNCONTROLLED POWER TOOL TO BE FORCED IN THE DIRECTION OPPOSITE OF THE ACCESSORY'S ROTATION AT THE POINT OF THE BINDING.

WARNING: KICKBACK IS THE RESULT OF POWER TOOL MISUSE AND/OR INCORRECT OPERATING PROCEDURES OR CONDITIONS AND CAN BE AVOIDED BY TAKING PROPER PRECAUTIONS AS GIVEN BELOW.

1. Maintain a firm grip on the power tool and position your body and arm to allow you to resist kickback forces. ALWAYS use the auxiliary handle, if provided, for maximum control over kickback or torque reaction during start-up. The operator can control torque reactions or kickback forces, if proper precautions are taken.
2. NEVER place your hand near the sanding pad. It may kickback over your hand.
3. DO NOT position your body in the area where power tool will move if kickback occurs. Kickback will propel the tool in the direction opposite to the sanding pads movement at the point of snagging.
4. Use special care when working corners, sharp edges etc. Avoid bouncing and snagging the sanding pad. Corners, sharp edges or bouncing have a tendency to snag the rotating accessory and cause loss of control or kickback.

DUST EXTRACTION

The dry wall sander is provided with a dust extraction facility. Please note however, that this does not preclude the user from wearing a face mask to prevent the inhalation of dust particles. All safety wear must be worn.

ELECTRICAL CONNECTIONS



WARNING: READ THESE ELECTRICAL SAFETY INSTRUCTIONS THOROUGHLY BEFORE CONNECTING THE PRODUCT TO THE MAINS SUPPLY.

Before switching the product on, make sure that the voltage of your electricity supply is the same as that indicated on the rating plate. Connecting it to any other power source may cause damage.

If it is necessary to change the fuse in the plug, the fuse cover must be refitted. If the fuse cover becomes lost or damaged, the plug must not be used until a suitable replacement is obtained.

If the plug has to be changed due to damage, a replacement should be fitted, following the wiring instructions shown below. The old plug must be disposed of as insertion into a mains socket could cause an electrical hazard.



**WARNING: THE WIRES IN THE POWER CABLE OF THIS PRODUCT ARE COLOURED IN ACCORDANCE WITH THE FOLLOWING CODE:
BLUE = NEUTRAL BROWN = LIVE**

If the colours of the wires in the power cable of this product do not correspond with the markings on the terminals of your plug, proceed as follows.

- The **Blue** wire must be connected to the terminal which is marked **N** or coloured **Black**.
- The **Brown** wire must be connected to the terminal which is marked **L** or coloured **Red**.

We strongly recommend that this machine is connected to the mains supply via a Residual Current Device (RCD)

If in any doubt, consult a qualified electrician. DO NOT attempt any repairs yourself.



This symbol indicates that this is a Class II product, and does not require an earth connection.

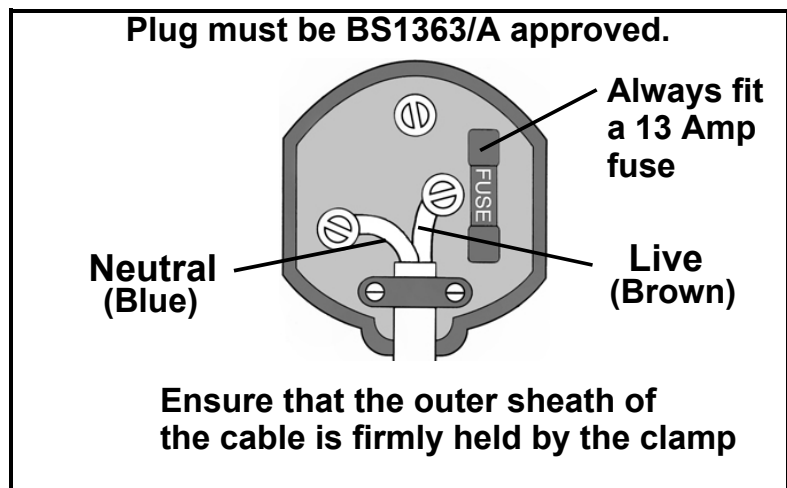

PRODUCT OVERVIEW



NO	DESCRIPTION
1	Main Sander Body
2	Extension Handle
3	Dust Bag
4	Dust Extraction Hose
5	Storage Bag

NO	DESCRIPTION
6	Spring
7	2 x Carbon Brushes
8	Allen Key
9	1 x P80 sanding disc 1 x P100 sanding disc 1 x P120 sanding disc 1 x P150 sanding disc 1 x P180 sanding disc 1 x P240 sanding disc

PREPARATION AND USE

FITTING A SANDING PAD

1. Ensure the sander is switched off and the plug is removed from the socket.
2. Remove the sanding disc.
3. Place the allen key in the hexagon hole in the centre of the sanding pad and rotate clockwise to remove pad
4. Place replacement sanding pad and tighten allen key anticlockwise.

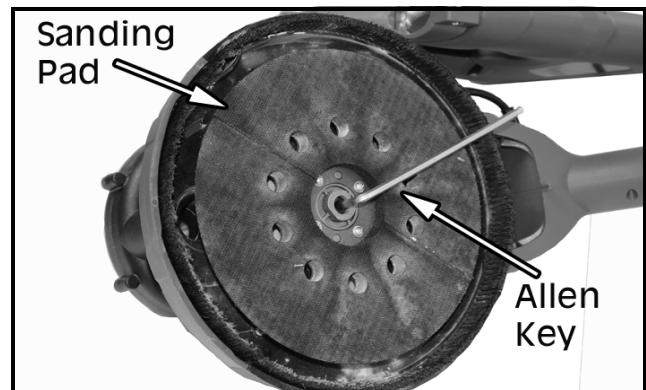

FITTING SANDING DISC

1. Ensure the sander is switched off and the plug is removed from the socket.
2. Select the sanding disc to be used.
 - This MUST be the correct 10 hole 225mm diameter disc with hook and loop backing.
3. Line up the holes in the disc with those on the sanding pad.
 - This is necessary for dust extraction purposes.
4. Press the disc firmly onto the pad to secure it using the hook & loop backing.

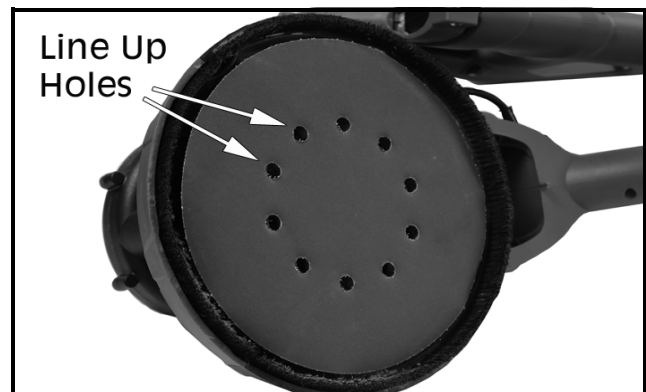

FITTING THE EXTENSION HANDLE & DUST BAG

1. Unfold handle and lock in place with locking wheel (P10).
2. Loosen the locking wheel on the underside of the handle.
3. Insert extension handle to required length and tighten locking wheel

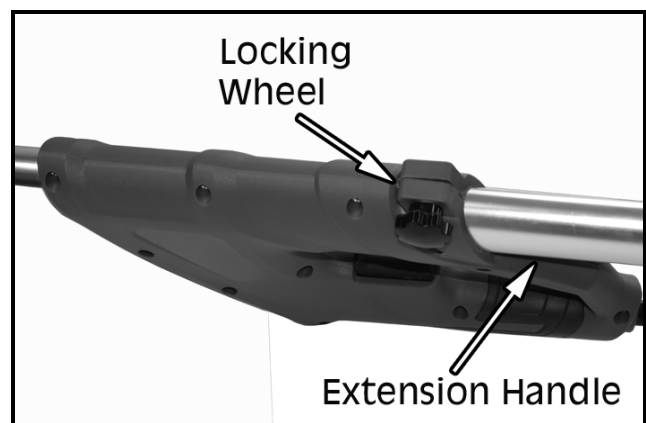

4. Attach hose to extension handle via twist & lock grommet and turn clockwise to lock into place.
5. Attach dust bag to hose via twist & lock grommet and turn clockwise to lock into place.

DUST COLLECTION

1. Ensure the sander is switched off.
2. Connect hose onto the dust extract port on the underside of the sander trigger handle.
3. Connect opposite end of hose onto dust collection bag.

NOTE: The dust bag must be emptied regularly;- do not wait until it is completely full.

The dust bag is emptied as follows.

1. Ensure the sander is switched off.
2. Gently squeeze the push & click connector to remove the dust bag from the hose.
3. Take the dust bag to the dustbin and slide the clip off the bag, empty the bag into the bin.
4. Reassemble the dust bag and clip and fit back on to the hose.

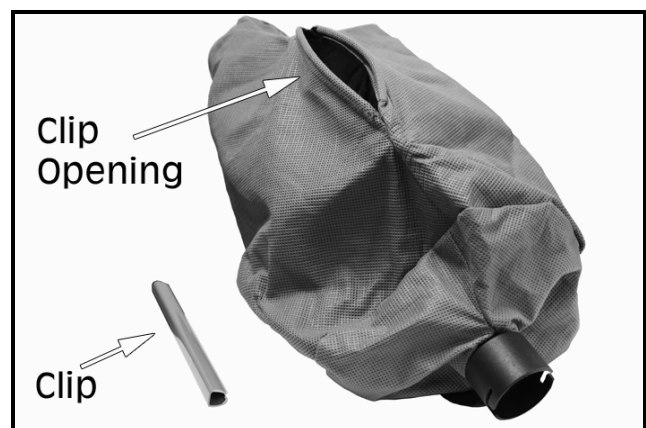
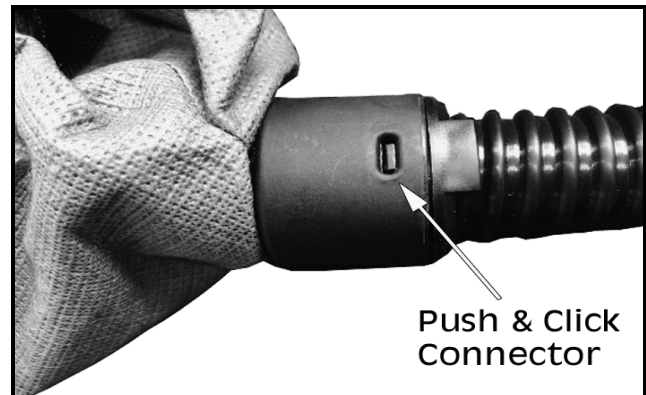

OPERATION

1. Unfold handle and lock in place with locking clamp. Careful to avoid trapping fingers.
2. Attach extension handle, dust hose and bag, as above.
3. Plug into the mains socket and switch on,
4. Set speed of sander, see page 11
5. Place the sanding disc on the workpiece.
 - Hold the sander firmly with both hands.
6. Squeeze the trigger.

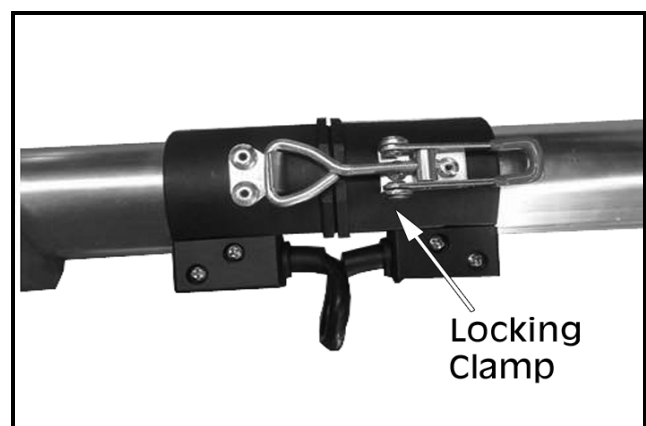

- Allow to get up to speed before working gently across the workpiece until smooth.

7. Release the trigger.

- Wait until the motor has stopped fully before putting the sander down.

LOCK ON FEATURE

For continuous sanding:

1. Squeeze the trigger and then press the LOCK ON button.
 - The sander will continue to run even if the trigger is released.
2. To release the lock on feature, squeeze the trigger again.

SPEED CONTROL

To control the speed settings, turn the speed control wheel located on the trigger handle to the required position.

1 = 800 rpm

2 = 1000 rpm

3 = 1200 rpm

4 = 1400 rpm

5 = 1600 rpm

Max = 1750 rpm

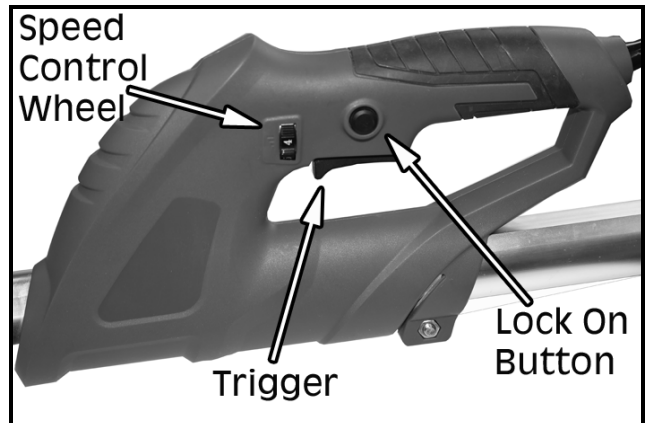

EDGE/CORNER SANDING

If there is a need to sand edges or corners of walls.

1. Press down on the release clip
2. Pull edge sanding cover away from main sander body

This will give access to 1/4 of the sanding disc edge for rounding edges and corners.



SANDING HIGH LEVEL & CEILINGS

The spring aids in the stability and positioning of the sander head when sanding high level or ceilings

1. Attached extension handle, dust hose and bag.
2. Attach spring to the front and rear spring eyelets as shown.

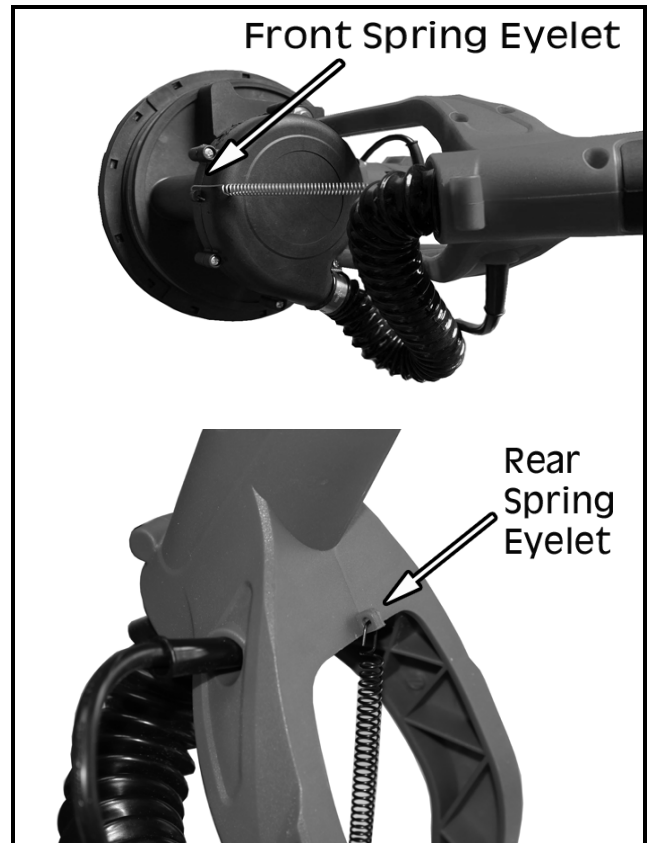

REPLACING CARBON BRUSHES

Both carbon brushes need replacing once either have less than 6mm length of carbon remaining.

1. Ensure the sander is switched off and the plug is removed from the socket.
2. Unscrew the plastic brush caps (1&2) found towards the rear of the motor housing on both sides. Be careful as the caps are spring loaded.
3. Withdraw the brush with its spring.

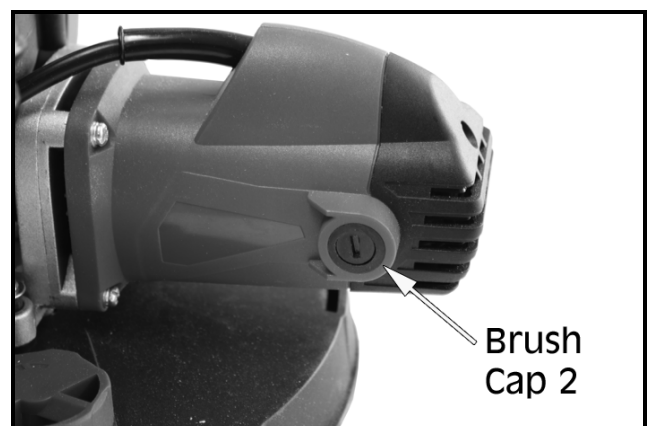
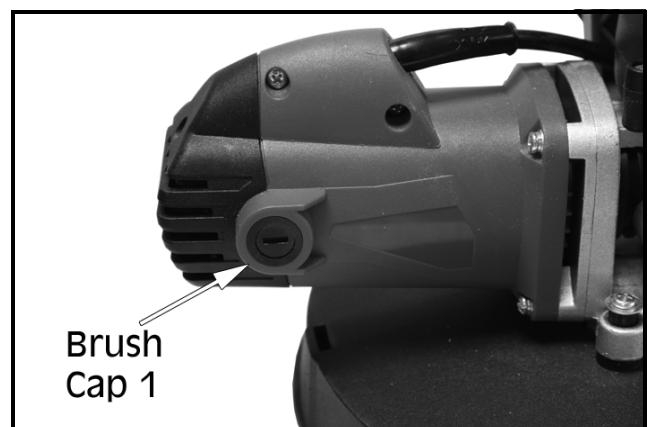

4. If replacement is necessary, renew the brush and replace the cap.

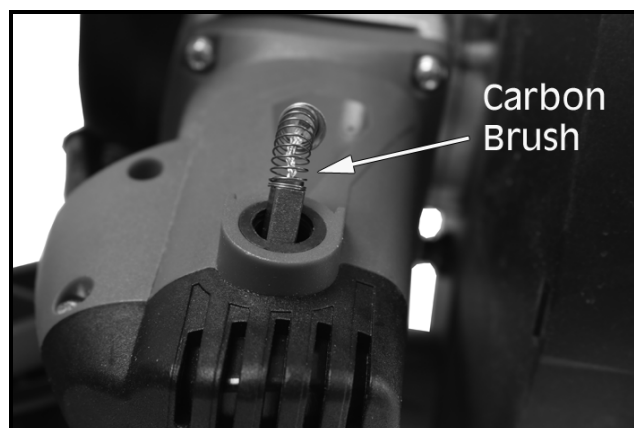

MAINTENANCE & TROUBLESHOOTING

MAINTENANCE

- ALWAYS inspect the sander before use and ensure it is in working condition.
- Ensure all air vents are clear. (Use vacuum cleaner to clean the machine where possible).
- Check the power cable to ensure it is sound and free from cracks, bare wires etc. Avoid using solvents when cleaning plastic parts, (most plastics are susceptible to damage from the various types of commercial solvents).

TROUBLESHOOTING

PROBLEM	CAUSE	REMEDY
Sander is overheating.	The machine is blocked with dust.	Clean the ventilation holes. Wipe the exterior with a dry cloth.
Excessive Sparking.	Worn brushes.	See page 12, replacing carbon brushes.
Sander does not operate when switched on.	Check to ensure the fuse in the plug is sound.	If the fuse is sound or blows repeatedly, consult your CLARKE dealer.
Dust is not extracted.	The dust bag is full or the dust extractor flue is blocked.	Remove and empty the bag, also clear any blockage.

REPLACEMENT DISCS

GRIT SIZE	PART NUMBER	GRIT SIZE	PART NUMBER
P60 (Pack of 5)	6502146	P150 (Pack of 5)	6502149
P80 (Pack of 5)	6502147	P180 (Pack of 5)	6502150
P120 (Pack of 5)	6502148	P240 9Pack of 5)	6502151

DECLARATION OF CONFORMITY



DECLARATION OF CONFORMITY

This is an important document and should be retained.

We hereby declare that this product(s) complies with the following statutory requirement(s):

Electromagnetic Compatibility Regulations 2016
Electrical Equipment (Safety) Regulations 2016
The Restriction of the Use of Certain Hazardous Substances in Electrical and Electronic Equipment Regulations 2012

The following standards have been applied to the product(s):

EN 55014-1:2017+A11:2020 EN 55014-2:2015, EN IEC 61000-3-2:2019, EN 61000-3-3:2013+A1:2019
BS EN 60745-1:2009+A11:2010, BS EN 60745-2-3:2011+A2:2013+A11:2014+A12:2014+A13:2015,
BS EN ISO 12100:2010, IEC 62321-5:2013, IEC 62321-7-2:2017, IEC 62321-6:2015.

The technical documentation required to demonstrate that the product(s) meet(s) the requirement(s) of the aforementioned legislation has been compiled and is available for inspection by the relevant enforcement authorities.

The UKCA mark was first applied in: 2022

Product Description: 750W Foldable Long Reach Drywall Sander
Model number(s): DWS225LR 230V
Serial / batch Number: N/A
Date of Issue: 14/02/2022

Signed:

J.A. Clarke
Director

DWS225LR 230 CE Clarke DOC 021422

Page 1 of 1



DECLARATION OF CONFORMITY

This is an important document and should be retained.

We hereby declare that this product(s) complies with the following directive(s):

2014/30/EU Electromagnetic Compatibility Directive.
2006/42/EC Machinery Directive.
2011/65/EU Restriction of Hazardous Substances (amended by (EU) 2015/863).

The following standards have been applied to the product(s):

EN 55014-1:2017+A11:2020 EN 55014-2:2015, EN 61000-3-2:2019, EN 61000-3-3:2013+A1:2019
EN 60745-1:2009+A11:2010, EN 60745-2-3:2011+A2:2013+A11:2014+A12:2014+A13:2015,
BS EN ISO 12100:2010, IEC 62321-5:2013, IEC 62321-7-2:2017, IEC 62321-6:2015.

The technical documentation required to demonstrate that the product(s) meet(s) the requirement(s) of the aforementioned directive(s) has been compiled and is available for inspection by the relevant enforcement authorities.

The CE mark was first applied in: 2020

Product Description: 750W Foldable Long Reach Drywall Sander
Model number(s): DWS225LR 230V
Serial / batch Number: N/A
Date of Issue: 14/02/2022

Signed:

J.A. Clarke
Director

DWS225LR 230 CE Clarke DOC 021422

Page 1 of 1

A SELECTION FROM THE VAST RANGE OF

Clarke®

QUALITY PRODUCTS



AIR COMPRESSORS
From DIY to industrial, Plus air tools, spray guns and accessories.

GENERATORS
Prime duty or emergency standby for business, home and leisure.

POWER WASHERS
Hot and cold, electric and engine driven - we have what you need

WELDERS
Mig, Arc, Tig and Spot. From DIY to auto/industrial.

METALWORKING
Drills, grinders and saws for DIY and professional use.

WOODWORKING
Saws, sanders, lathes, mortisers and dust extraction.

HYDRAULICS
Cranes, body repair kits, transmission jacks for all types of workshop use.

WATER PUMPS
Submersible, electric and engine driven for DIY, agriculture and industry.

POWERTOOLS
Angle grinders, cordless drill sets, saws and sanders.

STARTERS/CHARGERS
All sizes for car and commercial use.



PARTS & SERVICE: 0208 988 7400

Parts Enquiries
Parts@clarkeinternational.com

Servicing & Technical Enquiries
Service@clarkeinternational.com

SALES: UK 01992 565333 or Export 00 44 (0)1992 565335

Clarke® INTERNATIONAL Hemnall Street, Epping, Essex CM16 4LG
www.clarkeinternational.com